

Rieber

Tap into our stunning mixertap range...



Welcome to the Rieber range of kitchen mixers designed for people who want the ideal blend of modern design, high performance and pure quality. Each and every detail on a Rieber mixertap serves a purpose.

Every form performs a function, beautifully. And at the heart of the design, precise engineering and manufacturing quality ensure smooth, almost effortless control.

Your Local Stockist



BGL Rieber Ltd.

Unit 6, Lancaster Park Industrial Estate, Bowerhill, Melksham, Wiltshire. SN12 6TT

Sales Hotline +44 (0) 1225 70 44 70 Fax +44 (0) 1225 70 59 27

E-Mail sales@bglrieber.co.uk

www.rieber.de



Rieber Tap Range
January 2008



Angolo Professional

Specification

- Single Lever Ceramic Cartridge
- Variable Spray/Jet flow
- Requires 1.0 bar min operating pressure
- Spring 'pro' design spout
- Fittings

- Tail Pipe connections
 - Non Return Valves
- Finishes**
- Chrome
 - Brushed Steel

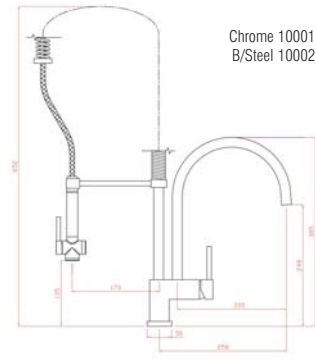

Chrome 10001
B/Steel 10002



Angolo Round Professional

Specification

- Single Lever Ceramic Cartridge
- Variable Spray/Jet flow
- Requires 1.0 bar min operating pressure
- Spring 'pro' design spout
- Tail Pipe connections

- Tail Pipe connections
- Finishes**
- Chrome

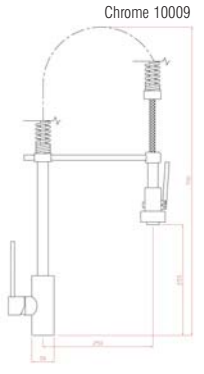

Chrome 10009



Angolo Top Lever

Specification

- Minimalist cubic design
- Ceramic Cartridge
- Single Flow Spout
- Fittings
- Integral spout and handle movement
- Requires 0.5 bar min operating pressure

- Tail Pipe connections
 - Integral Aerator
- Finishes**
- Chrome
 - Brushed Steel

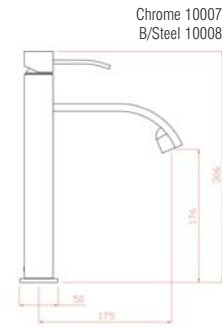

Chrome 10007
B/Steel 10008



Swan Quarter Turn Mixer

Specification

- Contemporary design
- Ceramic disc quarter turn valves
- Dual flow
- 0.3 bar min operating pressure

- Finishes**
- Chrome
 - Brushed Steel

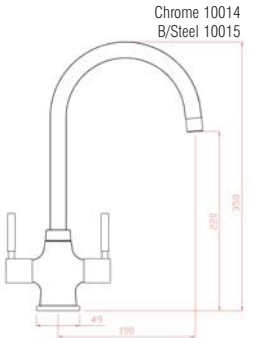

Chrome 10014
B/Steel 10015



Angolo Cruciform Monobloc

Specification

- Single Flow
- 2 x Ceramic Disc Cartridge
- Complete with all fittings
- Requires 0.3 bar min operating pressure
- Tail Pipe connections

- Non Return Valves
- Finishes**
- Chrome
 - Brushed Steel

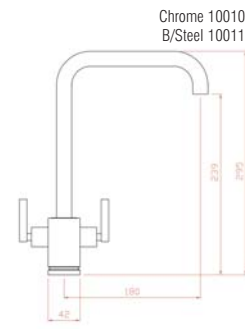

Chrome 10010
B/Steel 10011



Single Lever Mixer

Specification

- Ceramic Single Lever Cartridge
- Single Flow Spout
- Integral Aerator
- Requires 0.3 bar min pressure
- Tail Pipe connections

- Non Return Valves
- Finishes**
- Chrome
 - Brushed Steel

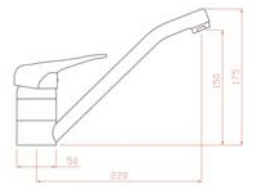

Chrome 10018
B/Steel 10019



Angolo Single Side Lever

Specification

- Single Flow Spout
- Ceramic cartridge
- Requires 0.5 bar min operating pressure
- Tail Pipe connections
- Non Return Valves

- Finishes**
- Chrome
 - Brushed Steel

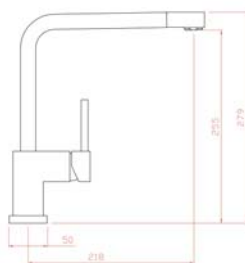

Chrome 10005
B/Steel 10006



Monobloc QT

Specification

- 2 x Ceramic Cartridges
- Integrated Flow Straightener
- Copper Tail Pipe connections
- Requires 0.2 bar min pressure
- Dual Flow Spout

- Finishes**
- Chrome
 - Brushed Steel

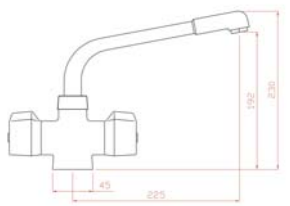

Chrome 10016
B/Steel 10017



Angolo Side Lever Pull Out

Specification

- Minimalist cubic design
- Ceramic Cartridge
- Single Flow Spout
- Integral spout and handle movement
- Requires 0.5 bar min operating pressure

- Fittings
 - Integral Aerator
- Finishes**
- Chrome
 - Brushed Steel

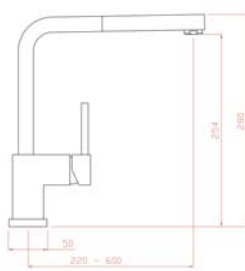

Chrome 10003
B/Steel 10004



Tower Single Lever /Pull Out Head

Specification Single Lever

- Mono Tower design
- Single lever ceramic cartridge
- 0.5 bar min operating pressure
- Swivel spout
- **Finishes Chrome & Brushed Steel**

Specification Pull Out Head

- Ceramic Single Lever Valve
- Single Flow Design
- Pull Out Head with Nylon Hose
- Requires 0.8 bar min operating pressure
- **Finishes Chrome**

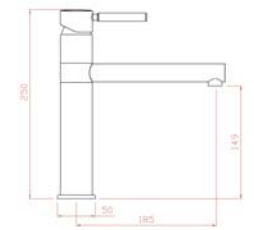

Chrome 10012 B/Steel 10013

Chrome 10020