

# UNITRAY

THE FIRST OF A NEW CLASS OF PRODUCTS



**rational**  
PRODUCTION



Rational  
PRODUCTION

17  
41  
23  
TRAY

WAITRAY

# UNITRAY

## **The first of a new class of truly unique products**

Rational Production has created a new, advanced class of products with improved characteristics, commencing with the company's flagship product, Unitray.

Unitray introduces a new concept, applied to all the products in the UNI line, and is designed to work in perfect synergy with the other unique products in the range.

# UNITRAY

**Unique because**  
*it defines a new class of trolleys*

Unitray is the new meal distribution trolley by Rational Production that defines new standards of quality. Unitray has been entirely redesigned with a view to becoming category leader: a new design, new materials and a meticulous focus on the ergonomics of the product and its management costs.

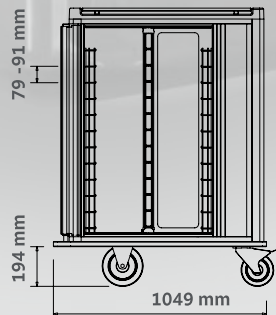
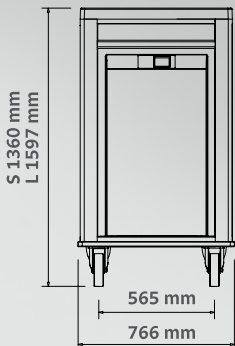

**FRONT**



**SIDE (A)**



**SIDE (B)**



### **MODERN**

A new design and new materials, together with an innovative manufacturing technology, define new product standards, combining shades of colour and essential forms to create solutions that blend in perfectly with any environment.

### **COMPACT**

The most compact trolley of its capacity on the market. The new generation Unitray occupies 12% less space, and is 6% lighter, reducing the space and effort required to manoeuvre the trolley. All the accessories are built-in to the lower product compartments.

### **HIGH-PERFORMANCE**

The trolley displays the highest performance levels in its category, allowing it to be used in all kinds of applications: C/S (cook & serve), C/C (cook & chill) and C/F (cook & freeze).

### **STURDY**

Exceptional resilience and sturdiness guaranteed by the new design with its all-round frame make the trolley suitable for use even in heavy duty environments.

### **SAFE**

The push handle has been designed to protect the user's hands from potential damage. The special door closure system guarantees that the trolley can be opened from within, in compliance with the safety legislation in force.

### **ECO-FRIENDLY**

The new manufacturing technology, and the materials used, enable all parts of the product to be replaced, making the trolley easier to maintain, guaranteeing a longer life cycle and increasing the eco-sustainability of the product.

### **ERGONOMIC**

Optimal push handle grip and position. Large colour display with user-friendly interface. Power cable positioned in the compartment custom-built into the side of the trolley, and optionals integrated into the lower product compartments, so that they are not in the operator's way.

### **CLEAN**

Easy to clean, thanks to the flush surfaces and wide angles at which they open out, both internally and externally.

### **CONVENIENT**

The design solutions adopted guarantee a product that is simple to maintain, and prolong the life of the product, bringing about a significant reduction in the management costs.

### **FLEXIBLE**

The optionals and accessories developed specifically for Unitray allow the trolley to be used to its full potential even in particular situations, including breakfast service or the integration of the multi-portion service in retirement homes.



# UNISERV PLUS

**Unique because**  
*it serves food perfectly*

Uniserv plus is the ideal partner of Unitray, a compact, ergonomic solution enabling the rapid transportation of food at temperatures that can be maintained for a long period, thanks to the inbuilt insulating system.

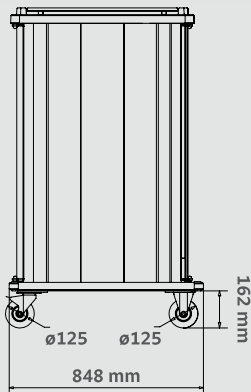
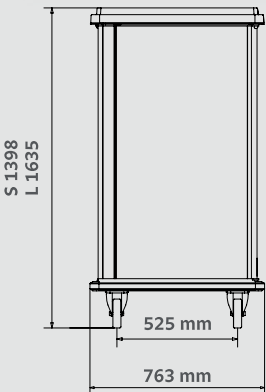

**FRONT**



**SIDE (A)**



**SIDE (B)**

# UNISERV STD

**Unique because**  
*it's fast and reliable*

Uniserv std is the sturdy, reliable, compact lightweight trolley designed for transporting food in entirely safe conditions, protecting it from damage and contamination. Its ergonomic shape makes it extremely easy to manoeuvre.

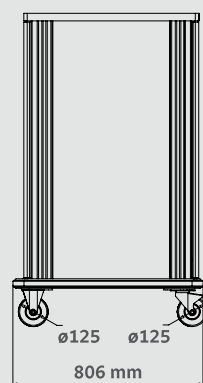
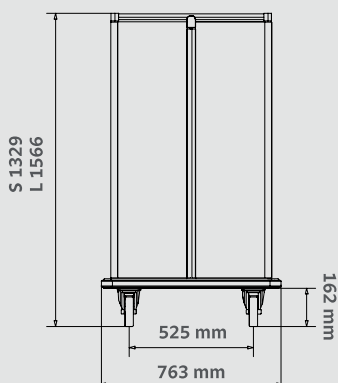

**FRONT**



**SIDE (A)**



**SIDE (B)**

# UNISERV JOLLY

**Unique because**  
*it's versatile, simple and cheap*

Uniserv jolly is designed to be versatile and easy to use, but at the same time, capable of transporting all the contents of Unitray quickly, efficiently and with the minimum obstruction.

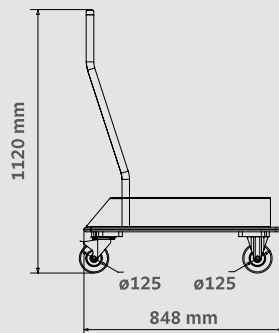
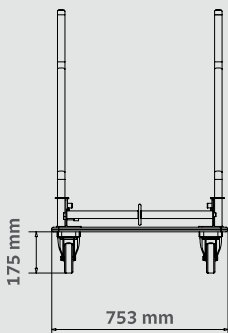

FRONT

SIDE (A)

SIDE (B)





# UNITRAY EXTRAS



## FOLDAWAY SHELF

The trolley can be supplied with a foldaway shelf on which to lay the trays during distribution or when clearing up.

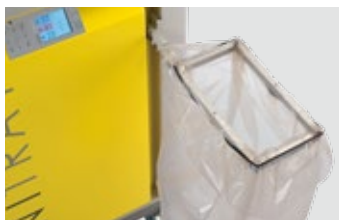

## BAG HOLDER

Unitray can be fitted with a bag holder/container support on one or both sides. Available in two versions: stand alone or combined with a foldaway shelf.



## COLOURS

Unitray is available in the colours yellow and blue.



## COMMUNICATOR USB SET-UP

Allows the user to download temperatures and alarms and re-program settings, using the USB interface. Data analysis and filing on the PC can be performed in compliance with the HACCP regulations, using the “Communicator USB” software.



## COMMUNICATOR PLUS SET-UP

Allows the trolley to be managed from A to Z in real time from a remote position. Data analysis and filing on the PC can be performed in compliance with the HACCP regulations, using the “Communicator PLUS” software.



## BASKET SET-UP

Allows a basket, complete with food and trays, to be transferred between a Uniserv service trolley and the Unitray trolley. With this optional, the movement and distribution of meals is easier as they are carried out by the service trolley, which is lighter and more compact.



## TYPES OF CASTORS

Unitray has a full range of castors: in stainless or galvanised steel with a 160mm or 200mm diameter. Centralised brake (on both the rotating castors). Castors with blocked rotation (to make the fixed castors rotate by allowing them to move to the side).



## REDUCED BUMPER

Reduces the length by 70mm making Unitray the smallest trolley in its category.



COOK & SERVE

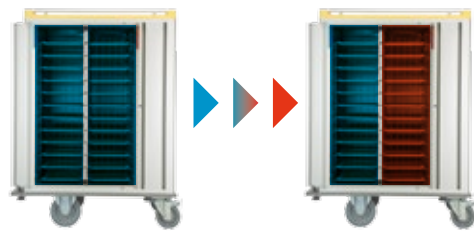

COOK & CHILL / COOK & FREEZE

### C/S - C/C - C/F USES

Unitray is available in various versions:  
C/S (COOK & SERVE): for maintaining food at the desired temperature, in both the cold and hot compartments.  
C/C (COOK & CHILL), C/F (COOK & FREEZE): for maintaining food cold in both compartments and regenerating the food in the hot compartment by activating the heat cycle at the appropriate moment, either manually or automatically.  
In both versions, there are four heat cycles which can be fully customised. In order to manage all requirements and ensure optimum performance.

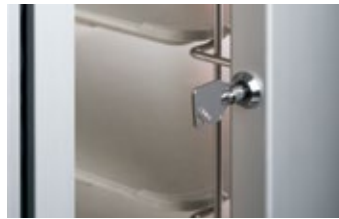

### LOCKING SYSTEM

The trolley doors can be locked to prevent them from being opened by unauthorised persons.



### MULTI POWER

The Multipower optional allows the power to be cut when the set temperatures are reached during the heat cycle, with a view to optimising the management of the power peaks in the equipment.



### 4 DOORS

The basic Unitray model is available in the 2-door model, but a 4-door version is also available as an optional, with a Roman blind closing system.



### TOWING HOOK

Enables up to 4 trolleys joined together to be moved, using appropriate towing equipment.

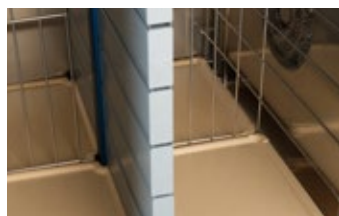

### TRAY SEPARATOR

Prevents the food moving from one tray to the next in the trolley during transportation.



### MOTORISATION

Unitray can be supplied in a motorised version, to allow the trolley also to be manoeuvred on routes with a gradient of up to 15%.



# UNITRAY ACCESSORIES



## STANDARD TRAY

Distribution of complete, customised hot and cold meals.

FORMAT	DIMENSIONS	COLOUR
GN	530x325 mm	milky coffee / yellow grey
EXT	565x332,5 mm	



## 1/2 TRAY

Distribution of a reduced menu. Breakfast distribution, for use with breakfast container shelf.

FORMAT	DIMENSIONS	COLOUR
1/2 GN	263x326 mm	milky coffee / yellow grey
1/2 EXT	280x332,5 mm	

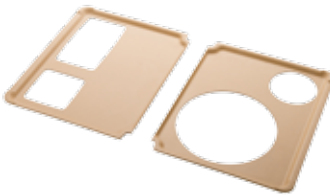

## PARKINSON'S KIT TRAY

For use combined with the standard trays in order to keep dishes still.

FORMAT	DIMENSIONS	COLOUR
2 X 1/2 GN	263x326 mm	milky coffee / yellow grey
2 X 1/2 EXT	280x332,5 mm	

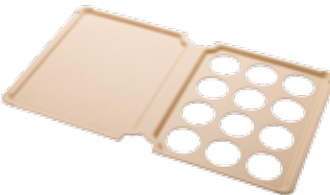

## TRAY FOR OVEN DISHES

Distribution of multi-portion menu.

FORMAT	DIMENSIONS	COLOUR
GN	530x325	milky coffee / yellow grey
EXT	565x332,5	

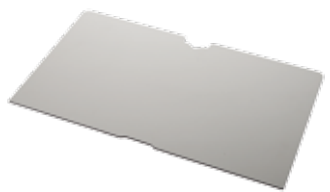

## BREAKFAST CONTAINER SHELF

Shelf for supporting containers during breakfast distribution.

FORMAT	DIMENSIONS	COLOUR
GN	530x325	milky coffee / yellow grey
EXT	565x332,5	



## FOOD PROBE

For use with the optional Communicator USB.

Allows the user to measure the temperature in the centre of the food and saves the relative data in the memory of the trolley.



### ROUND FLAT PLATE / LID

DIMENSIONS	MATERIAL	COLOUR
plate Ø215 mm	ceramics	white
lid Ø216 H53,5 mm	PP synthetic material	orange / yellow / grey

### ROUND FLAT PLATE WITH PUZZLES / LID

DIMENSIONS	MATERIAL	COLOUR
plate Ø215 mm	ceramics	white
lid Ø216 H53,5 mm	PP synthetic material	orange / yellow / grey

### 2-COMPARTMENT ROUND FLAT PLATE / LID

DIMENSIONS	MATERIAL	COLOUR
plate Ø215 mm	ceramics	white
lid Ø216 H53,5 mm	PP synthetic material	orange / yellow / grey



### RECTANGULAR DISH / LID

DIMENSIONS	MATERIAL	COLOUR
dish 177x111x35 mm	ceramics	white
lid 177x111x28 mm	PP synthetic material	orange / yellow / grey



### SQUARE DISH / LID

DIMENSIONS	MATERIAL	COLOUR
dish 120x120x42 mm	ceramics	white
lid 115x115x37 mm	PP synthetic material	orange / yellow / grey



### ROUND DISH / LID

DIMENSIONS / CAPACITY	MATERIAL	COLOUR
dish Ø135x69 mm / 0,5lt	ceramics	white
lid Ø122 H18 mm	PP synthetic material	orange / yellow / grey



### TRANSFER BASKET

Necessary for transferring an entire load of food and trays in one operation from a Uniserv service trolley to a Unitray trolley.

LENGTH	DIMENSIONS	WIDTH	TRAY CAPACITY
SMALL	611x665x997 mm	91,15	20
		79	24
LARGE	611x665x1234 mm	91,15	26
		79	30



### DEPARTMENT CODE

Useful accessory for assigning the use of, and/or attaching documents to the trolley.



# TECHNICAL DATA

## UNITRAY

DESCRIPTION	UNIT OF MEASURE	VALUE	
Dimensions (standard)	mm	SMALL 766x1049x1360	LARGE 766x1049x1597
Dimensions (with bumper down)	mm	SMALL 766x979x1360	LARGE 766x979x1597
Castor diameter	mm	FIXED 160 / 200 / ROTATING 160 / 200	
Degree of protection		IPX5	
Minimum temperature cold compartment	°C	-3	
Maximum temperature hot compartment	°C	130	
Type of trays		GN, EXT	
Weight	Kg	SMALL ~187	LARGE ~203
Working temperature	°C	from 5 to 43°C	
Gas refrigeration system		R134a	

## ELECTRIC POWER AND STANDARDS

POWER (KW)	CE 400V 16A 3F 50/60Hz	CE 230V 16A 1F 50/60Hz	CE 230V 20A 1F 50/60Hz	CE 230V 32A 1F 50/60Hz	CE 230V 16A 3F 50/60Hz	USE
9,8	x					C/F -C/C
7,3	x			x		C/S -C/C
6,5	x			x		C/S -C/C
4,6			x	x		C/S
3,7		x		x	x	C/S

## MEAL CAPACITY

MODEL	20 TRAYS	24 TRAYS	26 TRAYS	30 TRAYS
SMALL	width of 91,15 mm	width of 79 mm		
LARGE			width of 91,15 mm	width of 79 mm

## PRODUCT DESCRIPTION

APPLICATION	Trolley for the distribution of hot and cold food on a customised tray.
CONFIGURATION	Food regeneration equipment / thermo-ventilated temperature maintenance with built-in ventilated refrigeration.
EXTERIORS	Command panel: made of extremely shock-resistant thermoformed ABS. Top cover: in thermoformed ABS and aluminium, with built-in barrier. Push handle: ergonomic, horizontal grip designed to protect the hands. Body: in aluminium treated with high-density anodic oxidation and easy-to-clean, shock-resistant HPL panels. Doors: standard configuration with 2 doors, featuring a 270° angle of opening optional 4-door configuration with 270° Roman blind angle of opening. All-round bumper in high-density polyethylene.
INTERIORS	Chamber: in stainless steel, folds back fully and features flush surface joints to allow easy cleaning. Rotor fan cover and tray supports: in easily removable and washable stainless steel. Divider: In aluminium and synthetic material, fully washable, also in washing tunnel, with seals that can be replaced directly by the operator without the use of tools and without removing the divider.
DOORS	Composed of an aluminium frame, an outer panel in HPL, a central panel of insulating material and two inner panels in stainless steel. Easily removable silicon seals. Angle of opening 270°. Automatic closure with mechanism built into the edge to prevent knocks and breakages. Optional key locking system.
MATERIALS	AISI304 stainless steel, aluminium, synthetic material.

## UNISERV JOLLY

DESCRIPTION	UNIT OF MEASURE	VALUE
Dimensions (standard)	mm	753x848x1120
Castor diameter	mm	FIXED 125 / ROTATING 125
Cleaning		The trolley can be washed in a washing tunnel at a maximum water temperature of 65°C.
Type of basket		GN, EXT

### PRODUCT DESCRIPTION

APPLICATION	Open neutral service trolley for transporting baskets.
EXTERIORS	Base: in synthetic, shock-resistant material. Runners for supporting and gliding the basket in aluminium treated with high-density oxidation, featuring castors in synthetic material. Ergonomic push handles, made of aluminium treated with high-density oxidation.
MATERIALS	Aluminium, synthetic material.

## UNISERV STD

DESCRIPTION	UNIT OF MEASURE	VALUE
Dimensions (standard)	mm	SMALL 763x806x1329 LARGE 763x806x1566
Castor diameter	mm	FIXED 125 / ROTATING 125
Cleaning		The trolley can be washed in a washing tunnel at a maximum water temperature of 65°C.
Type of basket		GN, EXT

### PRODUCT DESCRIPTION

APPLICATION	Closed neutral service trolley for transporting baskets.
EXTERIORS	Body: in aluminium, treated with high-density anodic oxidation and easy-to-clean, shock-resistant HPL panels. Base: in aluminium, treated with high-density anodic oxidation and subsequently painted. 4 Doors with 270° opening. All-round bumper in rubber.
DOORS	Composed of a frame in aluminium, a handle treated with high-density anodic oxidation and a shock-resistant HPL panel. Angle of opening 270°.
MATERIALS	Aluminium, synthetic material.

## UNISERV PLUS

DESCRIPTION	UNIT OF MEASURE	VALUE
Dimensions (standard)	mm	SMALL 763x848x1398 LARGE 763x848x1635
Castor diameter	mm	FIXED 125 / ROTATING 125
Cleaning		The trolley can be washed in a washing tunnel at a maximum water temperature of 65°C.
Type of basket		GN, EXT

### PRODUCT DESCRIPTION

APPLICATION	Closed, insulated neutral service trolley for transporting baskets.
EXTERIORS	Top cover: in thermoformed ABS and aluminium, with built-in barrier. Body: in aluminium treated with high-density anodic oxidation and easy-to-clean, shock-resistant HPL panels. Buffer: in aluminium, treated with high-density anodic oxidation and subsequently painted. 2 Doors with 270° opening. All-round bumper in rubber.
INTERIORS	Chamber: in stainless steel, folds back fully to allow easy cleaning. Runners for supporting trays in synthetic material.
DOORS	Composed of an aluminium frame, an outer panel in HPL, a central panel of insulating material and an inner panel in stainless steel. Angle of opening 270°. Automatic closure with mechanism built into the edge to prevent knocks and breakages.
MATERIALS	Stainless steel AISI304, aluminium, synthetic material.

**rational**  
**PRODUCTION**

---

**ANGELO PO | GROUP**

**RATIONAL PRODUCTION srl unipersonale**

---

Via L. Galvani, 7/H  
24061 Albano S. Alessandro (BG) Italy  
T. +39 035.452.1203  
F. +39 035.452.1983  
info@rationalproduction.com  
www.rationalproduction.com

---

**[www.unitray.it](http://www.unitray.it)**