

Metos Proveno Combi Jacketed Kettle

Model – Proveno Combi 40E ELECTRIC code 4222900C



Standard features

- Proveno kettle with integrated mixer
- Stepless mixing speed 15-140 rpm/min, autoreverse
- Elevated control pillar with guiding touch panel
- Audiovisual signals for user
- Multi functional timer
- Programming on screen, unlimited number of programs and program phases, favourite pages
- Programs for basic foods and wash programs
- Mixing patterns and saving of your own patterns
- ProTemp – real time temperature control, food and jacket temperature separately controlled. Intelligent power setting from gentle warming to full power. Allows for example low temperature cooking, sous vide, proving and tempering.
- Delta T cooking – temperature of jacket rises accordingly when food temperature rises, temperature difference is determined.
- User privilege levels
- Safety grid lid
- Strainer plate
- Recoiled handshower
- Automatic measured water filling
- Electric tilting
- Tilting while mixing function
- Auto tilt-back
- USB Port on control panel for program updates, program transfers and HACCP data saving
- Teacher status for practising
- Diagnostics for maintenance
- Energy and water consumption measuring
- Steam jacket automatic fill
- Measuring stick

Please refer to Metos website for options and accessories

Materials

- Construction stainless steel
- Inner surface acid proof stainless steel
- Cooking pot is welded and seamless
- Closed cell polyurethane foam insulation for increased energy efficiency and more robust construction
- Protection class IPX5

Technical Data

Proveno 40E

Net Volume	40 L
Spare Volume	8 L
Gross Volume	48 L
Water Cold	Ø 15 mm
Water Hot	Ø 15 mm
Heat load total / sensible / latent	12 kW / 2.4 kW / 0.4 kW
Electrical Power	14.0 kW
Voltage	400-415V 3P+N+E 50/60Hz
Fuse/3xA	32

Disclaimer: All unit capacities are based on subjective testing. In line with policy to continually develop and improve its products, Metos Oy Ab reserves the right to change specifications and design without notice.

NOTE

Mandatory installation kit required for all installations, options are:

Single kettle surface	code 4222188
Single kettle subsurface	code 4222190
Group kettle surface	code 4222192
Group kettle subsurface	code 4222194



Proveno	L1 (mm)	H (mm)	K (mm)	L (mm)	M (mm)	E (mm)	U (mm)	T (mm)	Door (mm)	N (mm)	Weight (kg)
40E	597	1740	900	870	1055	100	800	400	800	600	215

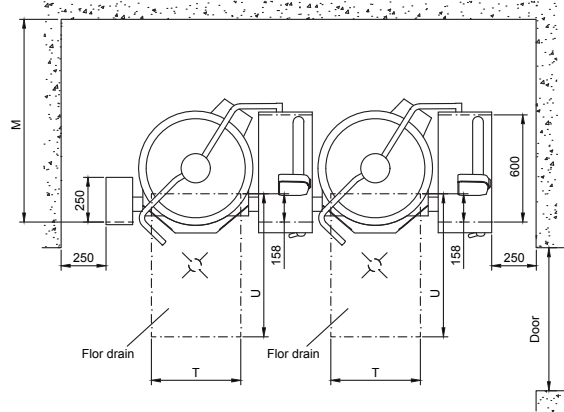
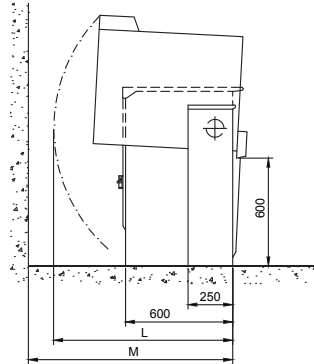
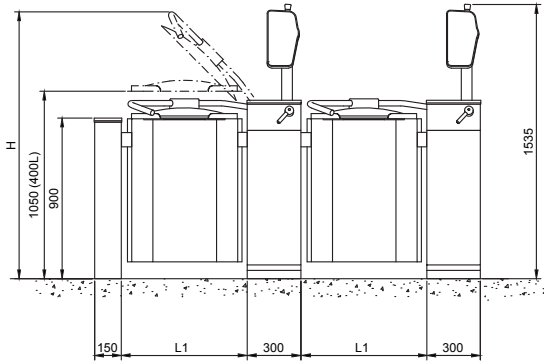

1. Electrical connection, PG36/PG29 gland
2. Cold water connection R1/2" (ø15), to be fitted with one way valve and shut off valve
3. Hot water connection R1/2" (ø15), to be fitted with one way valve and shut off valve (option)
4. Ice bank cooling inlet R3/4" max. pressure 3 bar, flow 90L/min. (option)
5. Ice bank cooling outlet R1" (option)
6. Ice bank cooling control cable (option)
7. HACCP cabling (option)
8. Power management system control cable (option)
10. Condensate outlet R1/2" / R3/4" (option)
11. Compressed air inlet R1/2" (option)
12. Twin water inlet R1/2" (option)

A. Electrical connections from rear

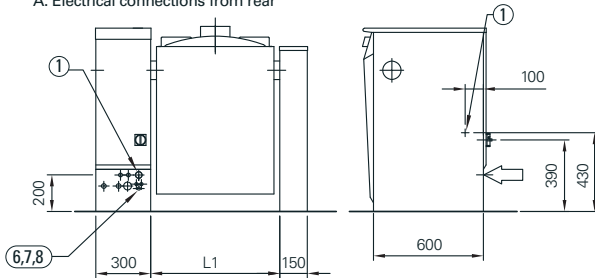

A. Water and steam connections from rear

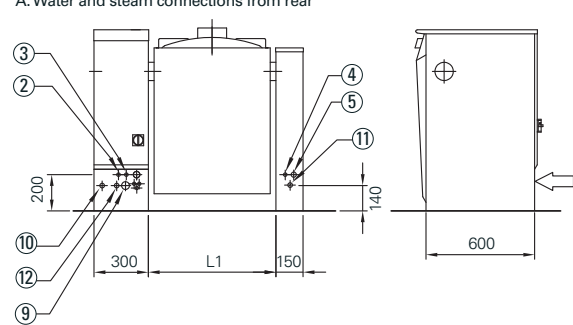

B. Electrical connections from below

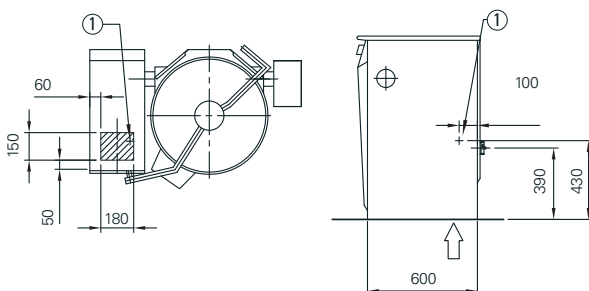

B. Water and steam connections from below

